

# DARIAH Update

9th FIM4R Workshop

Vienna, November 30, 2015

Peter Gietz, DAASI International GmbH



[www.dariah.eu](http://www.dariah.eu)

# What is DARIAH?

DARIAH: Digital Research Infrastructure for the Arts and Humanities

One of the few ESFRI research infrastructures for the humanities (**ERIC is in working mode by now**)

DARIAH's mission is to develop, maintain and operate an infrastructure in support of ICT-based research practices

Infrastructure is administration, software and storage services but also Curricula and Methodology

Working with communities of practice: humanities scholars supporting their VREs

# Humanities VRE



The screenshot displays the TextGrid Lab application window. The main workspace shows a handwritten document with several rectangular annotations in purple and red. A Toolkit panel on the right provides editing tools. Below the workspace, the XML editor shows the following code:

```
<sp>
  <speaker><anchor xml:id="a1" />ANDRES<anchor xml:id="a2" /></speaker>
  <stage><anchor xml:id="a3" />(nach einer Pause.)<anchor xml:id="a4" /></stage>
  <p><anchor xml:id="a5" />Woyzeck<anchor xml:id="a6" />
  <anchor xml:id="a7" />hörst<anchor xml:id="a8" />
  <anchor xml:id="a9" />du's<anchor xml:id="a10" />
  <anchor xml:id="a11" />noch?<anchor xml:id="a12" /></p>
</sp>
<sp>
  <speaker>WOYZECK</speaker>
  <p>Still, Alles still, als wär die Welt todt.</p>
</sp>
<sp>
  <speaker>ANDRES</speaker>
  <p>Hörst du? Sie trommeln drin. Wir müssen fort.</p>
</sp>
```

The status bar at the bottom indicates 'Rectangle mode', 'image/jpeg', and coordinates 'a: 255, r: 165, g: 165, b: 165'. The bottom right corner shows the email address 'testuser@textgrid.de'.

# DARIAH VCC Virtual Competence Centers



VCC Advocacy

VCC Research  
and Education

VCC  
e-Infrastructure

VCC Scholarly  
Content  
Management

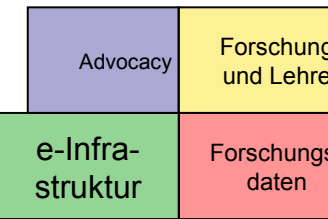

DARIAH-AT

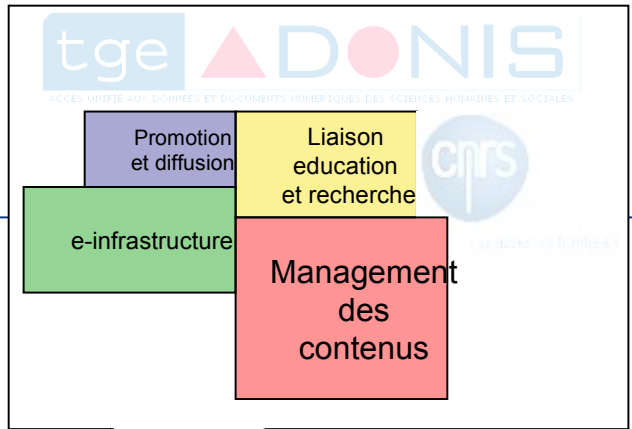
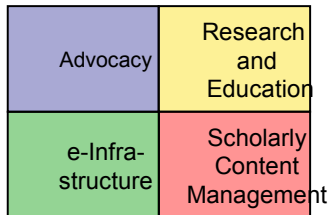

DARIAH-FR

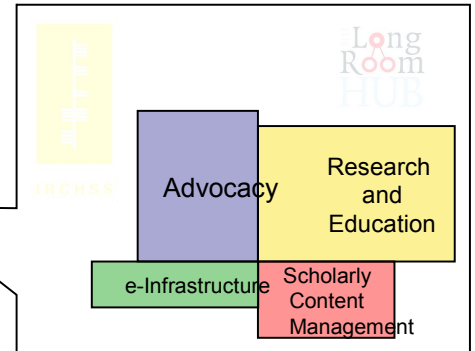

DARIAH-IE



# DARIAH AAI Practice

Current AAI set-up: a first version of an AA infrastructure has been deployed, based on two standards:

- LDAP (Lightweight Directory Access Protocol)
  - for authentication and authorization attributes
  - deploying Open Source Software OpenLDAP
- SAML (Security Assertions Markup Language)
  - for AAI within a federation
  - including Web Single Sign-On feature
  - deploying Open Source Software Shibboleth

# DARIAH AAI Setup

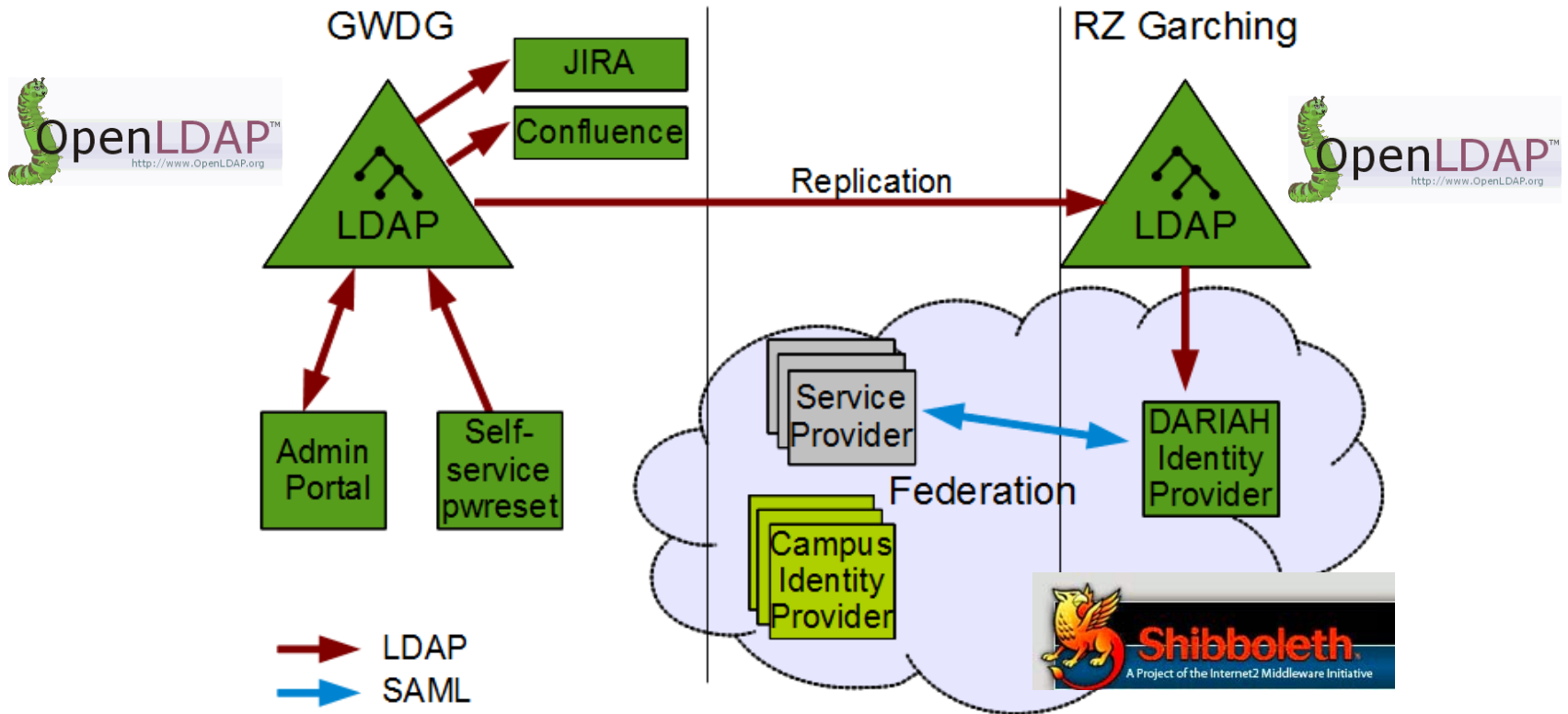

# VO Management and FIM in DARIAH

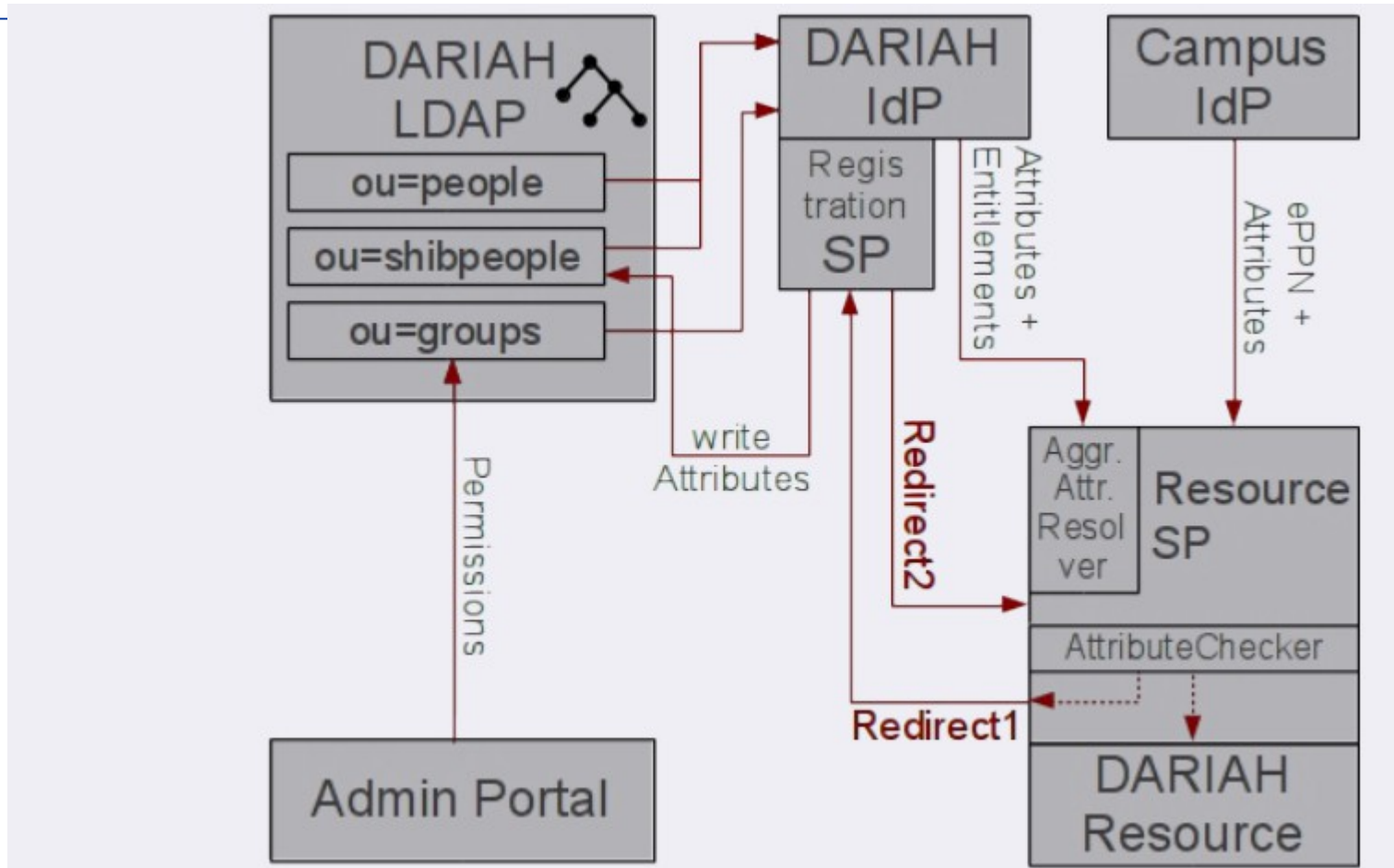

# VO Management and FIM in DARIAH

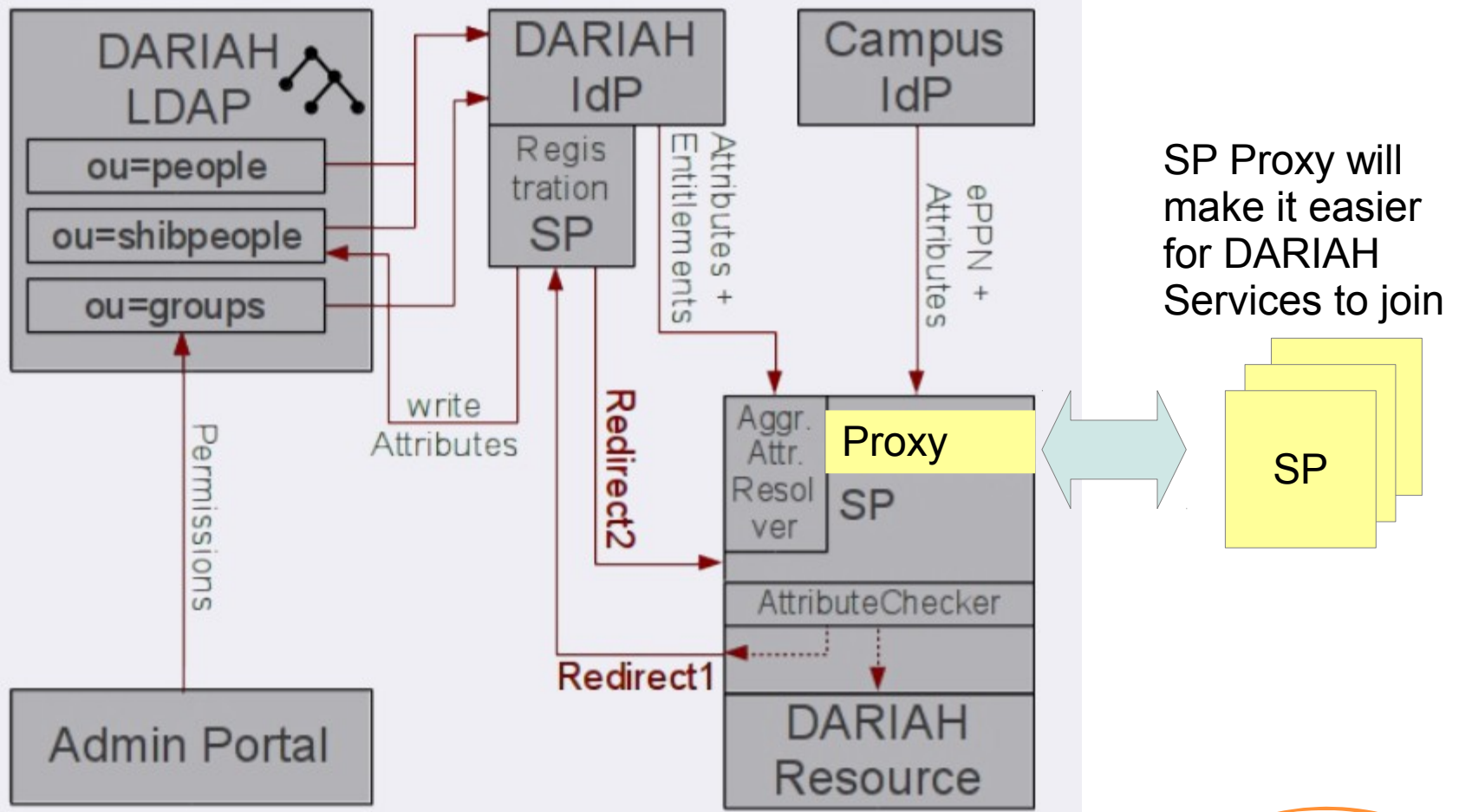



# Current Challenge

- European-wide federation eduGain has too little outreach
- Not every institution signs federation contracts
- Not every Identity Provider releases personal attributes
- Technologies for non-web-based access only  
“almost there” (ECP, STS, Moonshot, oAuth2)
- **Fine grained access control on file level , observed within a data replication federation (= non web SSO)**

# New Access Control Architecture

OAuth2 Client Credentials Grant  
Self-contained Access+Refresh Tokens  
Server-hosted Application

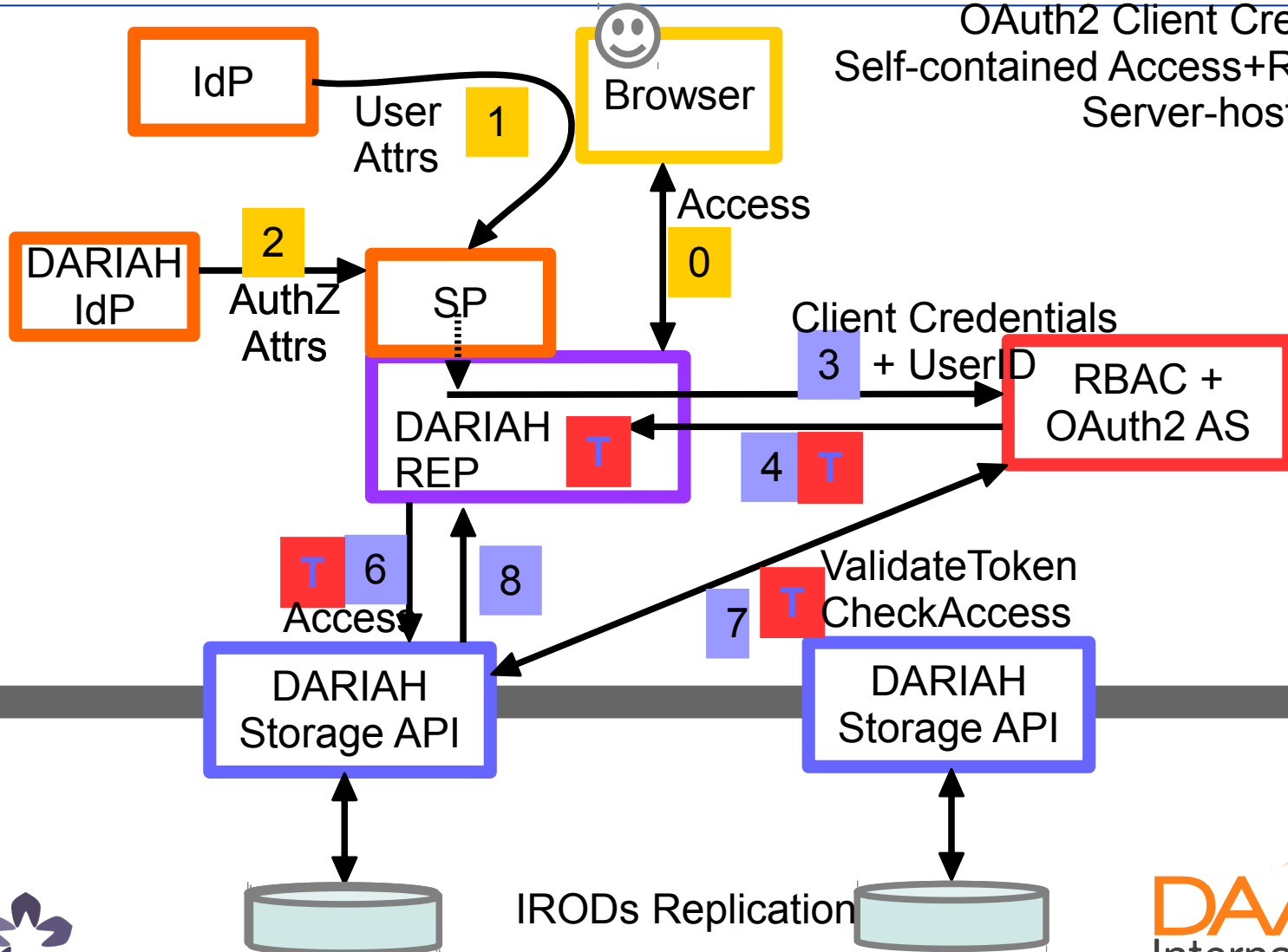

# Current figures

- We currently have **>3100 Users (700 new since February)**
- Still most do not log in via their home IdP
  - It's easier (and sort of familiar) to create a new DARIAH account
- We currently have **>250 different user groups (40 new since February)**
  - Every project usually uses three or four privilege groups (thus ca. **75 projects ca. 15 new since February**):
    - X-users, X-contributors, [X-developppers],  
X-admins

# How to make this a European-wide Infrastructure

- The management of the delegation is based on organisational roles (not groups) that are structured in a 3 level hierarchy :
- **DARIAH Coordination Office** as Top of hierarchy
  - Each Country has a **National Representative** who is allowed to:
    - Create and manage organisations and the organisation admin role
    - Each **Organisation** in a country has a organisation admin
      - **Organisation admin** is allowed to:
        - Create and manage groups (of projects the organisation is leading)
        - Create 'homeless'-accounts if needed

**Production ready Administration interface is there**

# New Features of User Management

- The Web-based administration and self-service interfaces have been improved, e.g.
  - Distributed user management
  - Better password forgotten processes
  - Completed role based administration
  - Concept of initial group is implemented
- Since the administration interface is actually used, new requirements pop up quite often

## Screenshots of Selfservice and Administrationinterface

[Start](#)[Forgot Password](#)[Account Registration](#)

## Request a DARIAH Account

Please provide details about yourself. Mandatory fields are marked with an asterisk.

**Given Name \*****Surname \*****E-Mail \***

Please enter your institutional e-mail address and *no private or commercial account* if possible.

**Organisation \*****Initial group**

Please choose...

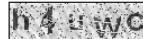
**Terms of Use \*** I accept the Terms of Use for DARIAH-DE.**Captcha \*****Remarks**[Request Account](#)

Visit the DARIAH Wiki  
© DAASI International

# DARIAH Account Administration



[Organisations](#) / [Login](#) /

[Help texts](#)

[Home Page](#)

## Login to the System

Please enter Login Name and Password

**Login**

**Password**

Login

[Visit the DARIAH Wiki](#)  
© DAASI International







# DARIAH Account Administration



Logged in as MartinHaase

Organisations / role select /

Help texts

Home Page

Search

Complex Search

New Account

Groups

LDAP Statistics

Account-Anträge

Change Role

Log Out

## Select your session role

You have privileges on more than one sub tree. Please select the subtree, you want to work on now

subtree

National Representative, DE, organisations, dariah

weiter

Visit the DARIAH Wiki  
© DAASI International





# DARIAH Account Administration



Logged in as MartinHaase, National Representative - DE

Organisations / Complex Search /

Help texts

- Home Page
- Search
- Complex Search**
- New Account
- Groups
- New Organisation
- LDAP Statistics
- Organisations
- Account-Anträge
- Change Role
- Log Out

## Complex Search

Please enter the search terms

**Given Name**

**Surname**

**Login**

- Please select**
- All fields must match
  - Only one field must match

Start search

Visit the DARIAH Wiki  
© DAASI International





# DARIAH Account Administration

Logged in as MartinHaase, National Representative - DE



Organisations / Group Management /

Help texts

Home Page

Search

Complex Search

New Account

Groups

New Organisation

LDAP Statistics

Organisations

Account-Anträge

Change Role

Log Out

## Group Management

You can edit the following groups:

Group name	Owner		
admins	uid=pgietz,ou=people,dc=dariah,dc=eu	Modify	Delete
ag-netzpolitik-contributors	uid=groupowner,ou=dsa,dc=dariah,dc=de	Modify	Delete
aib-admins	uid=groupowner,ou=dsa,dc=dariah,dc=eu	Modify	Delete
aib-contributors	uid=groupowner,ou=dsa,dc=dariah,dc=eu	Modify	Delete
aib-developers	uid=groupowner,ou=dsa,dc=dariah,dc=eu	Modify	Delete
aib-users	uid=groupowner,ou=dsa,dc=dariah,dc=eu	Modify	Delete
cendari-admins	uid=groupowner,ou=dsa,dc=dariah,dc=eu	Modify	Delete
cendari-contributors	cn=cendari-admins,ou=groups,dc=dariah,dc=eu	Modify	Delete
cendari-user	cn=cendari-admins,ou=groups,dc=dariah,dc=eu	Modify	Delete
collection-registry-admins	uid=groupowner,ou=dsa,dc=dariah,dc=eu	Modify	Delete
collection-registry-contributors	uid=groupowner,ou=dsa,dc=dariah,dc=eu	Modify	Delete



# DARIAH Account Administration



Logged in as MartinHaase, National Representative - DE

Organisations / Account Requests /

Help texts

Home Page

Search

Complex Search

New Account

Groups

New Organisation

LDAP Statistics

Organisations

Account Requests

Change Role

Log Out

## Account Requests

The following account requests exist in the system.

	Vorname	Name	Organisation	E-Mail	Begründung	Nr.
<input type="checkbox"/>	Find	Mich	asdfasdf	fm@daasi.de		7
<input type="checkbox"/>	mir	egal	asdfgasdf	egal@daasi.de		8
<input type="checkbox"/>	Verstecke	Mich	awefjanf	vm@daasi.de		9
<input type="checkbox"/>	Willi	Nichi	werden	gefunden@daasi.de		10
<input type="checkbox"/>	Und	ich	will	ui@daasi.de		11
<input type="checkbox"/>	Minimaler	Account	Da wir keine Organisation haben, erstmal Freitext.	minimal@daasi.de		12
<input type="checkbox"/>	Maximaler	Account	Noch eine Organisation	maximal@daasi.de		13
<input type="checkbox"/>	Neu	Maximal	Fasdfjkad	neumax@daasi.de		14
<input type="checkbox"/>	Hadsch	Al-Arab	asdlfjad	hasch@daasi.de		15
<input type="checkbox"/>	asdfgyasdf	asdgasdf	asdfs	asdfgasdfg@daasi.de		16
<input type="checkbox"/>	Murks	Maskr	alsdkjakjd	asdkfj@daasi.de		17
<input type="checkbox"/>	Sowieso	was	asdlfjk	asdfgasdfg@daasi.de		18



# DARIAH Account Administration

Logged in as MartinHaase, National Representative - DE

## Account Requests

- Home Page
- Search
- Complex Search
- New Account
- Groups
- New Organisation
- LDAP Statistics
- Organisations
- Account Requests
- Change Role
- Log Out

Organisations / Account Requests /

Help texts

## Account Requests

The following account requests exist in the system.

	Vorname	Name	Organisation	E-Mail	Begründung	Nr.
<input type="checkbox"/>	Find	Mich	asdfasdf	fm@daasi.de		7
<input type="checkbox"/>	mir	egal	asdfgasdf	egal@daasi.de		8
<input type="checkbox"/>	Verstecke	Mich	awefjanf	vm@daasi.de		9
<input type="checkbox"/>	Willi	Nichi	werden	gefunden@daasi.de		10
<input type="checkbox"/>	Und	ich	will	ui@daasi.de		11
<input type="checkbox"/>	Minimaler	Account	Da wir keine Organisation haben, erstmal Freitext.	minimal@daasi.de		12

Yes:  
Responsive  
design

# DARIAH Account Administration



Logged in as MartinHaase, DCO-admin - organisations

Organisations / Browse / [Help texts](#)

- Home Page
- Search
- Complex Search
- New Account
- Groups
- New Country
- LDAP Statistics
- Countries**
- Account Requests
- Change Role
- Log Out

## Browse in tree

you can browse through your subtree

Current entry:

DCO-admin, organisations, dariah	
DE, organisations, dariah	<a href="#">open</a>
IT, organisations, dariah	<a href="#">open</a>
NL, organisations, dariah	<a href="#">open</a>
GB, organisations, dariah	<a href="#">open</a>
IR, organisations, dariah	<a href="#">open</a>
GR, organisations, dariah	<a href="#">open</a>
BE, organisations, dariah	<a href="#">open</a>

[modify organisations, dariah](#)

Visit the DARIAH Wiki  
© DAASI International



# DARIAH Account Administration



Logged in as MartinHaase, DCO-admin - organisations

Organisations / Modify country /

Help texts

- Home Page
- Search
- Complex Search
- New Account
- Groups
- New Country
- LDAP Statistics
- Countries**
- Account Requests
- Change Role
- Log Out

## Modify country

Please modify the contry data

**Land**

**Description**

**National Representative**



- cancel
- + add national representative
- save

Visit the DARIAH Wiki  
© DAASI International



# DARIAH Account Administration



Logged in as MartinHaase, DCO-admin - organisations

Organisations / New Group Member /

Help texts

- Home Page
- Search
- Complex Search
- New Account
- Groups
- New Country
- LDAP Statistics
- Countries**
- Account Requests
- Change Role
- Log Out

## New Group Member (Make selected to GB)

The following entries were found:

	Vorname	Name	Login	Affiliation	Abteilung	Status
<input type="checkbox"/>	Martin	Haase	MartinHaase	DAASI International GmbH		TRUE
<input type="checkbox"/>	Martin	Haase		DAASI		
<input type="checkbox"/>	Martin	Haase		Thalheim		

Select all

◀ back + ad to group GB

Visit the DARIAH Wiki  
© DAASI International





# DARIAH Account Administration



Logged in as MartinHaase, DCO-admin - organisations

Organisations / Check new account /

Help texts

Home Page

Search

Complex Search

New Account

Groups

New Country

LDAP Statistics

Countries

Account Requests

Change Role

Log Out

## Create new account, step 1: check for existence

Please enter your search terms

Given Name

Henry

Surname

Hubble

Enter your surname or family name.

Check for existence

Visit the DARIAH Wiki  
© DAASI International



[Home Page](#)[Search](#)[Complex Search](#)[New Account](#)[Groups](#)[New Country](#)[LDAP Statistics](#)[Countries](#)[Account Requests](#)[Change Role](#)[Log Out](#)

## Create New Account

Please enter the user's data

**Login**

Will be created automatically if this field is left empty.

**Surname****Given Name****E-Mail****Organisation****Language** German English**Activation data**

Notification of new account will be sent at that date. Will be sent immediately if empty.

**Deletion data**

Account will be deleted at that date. Will not be deleted automatically if empty.

**Initial group****Description**



# DARIAH Account Administration



Logged in as MartinHaase, National Representative - GB

Organisations / Create Organisation /

Help texts

Home Page

Search

Complex Search

New Account

Groups

New Organisation

LDAP Statistics

Organisations

Account Requests

Change Role

Log Out

## Create New Organisation

Please enter the organisation's data

Organisation

KIng's College London

Description

Some description|

Orgadmin

save

save and add organisation administrator

Visit the DARIAH Wiki  
© DAASI International



# DARIAH Account Administration



Logged in as MartinHaase, National Representative - GB

Organisations / Modify Organisation /

Help texts

Home Page

Search

Complex  
Search

New Account

Groups

New  
Organisation

LDAP Statistics

Organisations

Account  
Requests

Change Role

Log Out

## Modify Organisation

Please modify the organisation's data



**Organisation**

**Description**

**Orgadmin**



 cancel

  add orgadmin

  save

Visit the DARIAH Wiki  
@ DAASI International



# Sustainability

- There is the strong will to make DARIAH a sustainable infrastructure
- One of the 6 Project Cluster of DARIAH-DE is DARIAH eHumanities Infrastructure Service Unit (DeISU)
  - We will be working on organizational model and business model
  - That service unit could well also operate AAI services

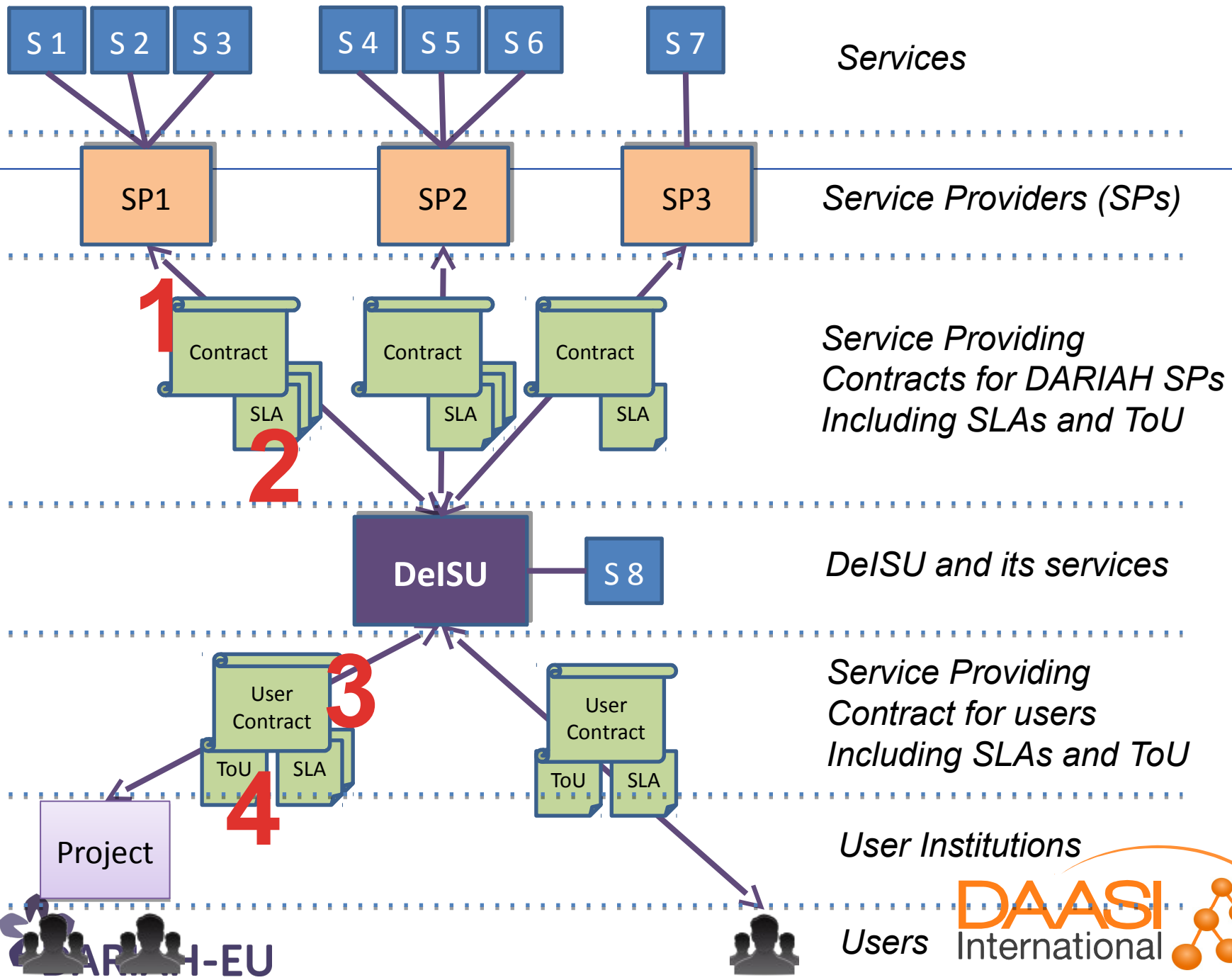

S 1 S 2 S 3

S 4 S 5 S 6

S 7

*Services*

SP1

SP2

SP3

*Service Providers (SPs)*

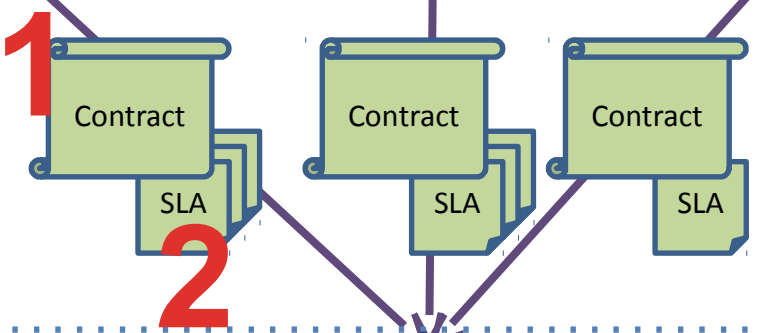

*Service Providing Contracts for DARIAH SPs Including SLAs and ToU*

DeISU

S 8

*DeISU and its services*

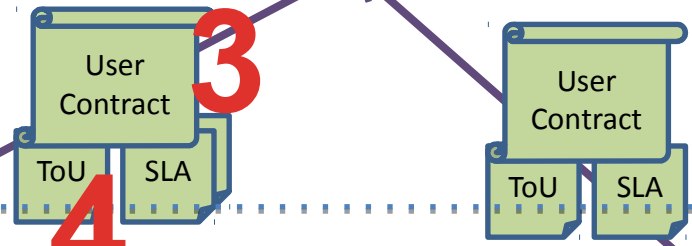

*Service Providing Contract for users Including SLAs and ToU*

Project



*User Institutions*

*Users*



# Summary

- DARIAH has a productive solution based on homeless-IdP and attribute authority
- Distributed user and privilege administration
- Roadmap for a sustainable service unit
- Policies that allow for integration into DFN-AAI and thus into eduGain
- DARIAH is actively co-operating with AARC

# Thank you for listening!

Questions?

Comments?